

**Diamond Dan Publications presents...**

# **The 2022 Mineral & Crystal Coloring Book**

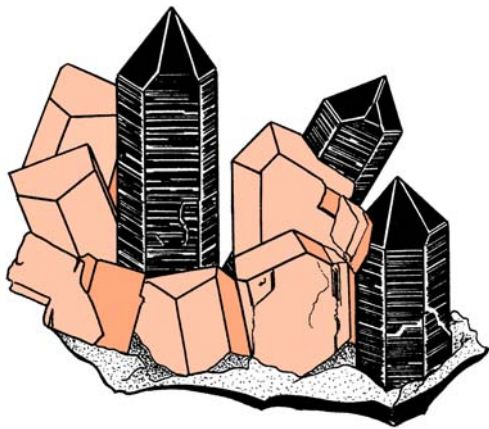

**A Collection of the Colorful Minerals Found in Nature**

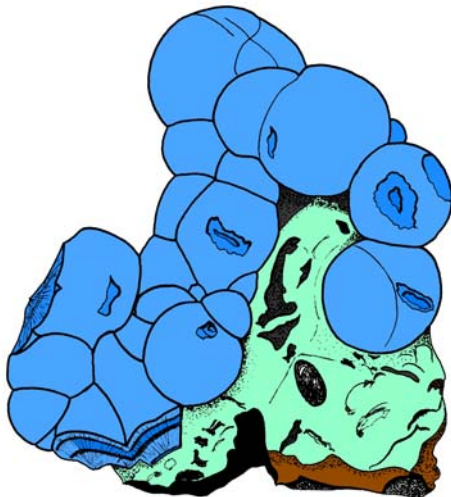

**By Darryl Powell**

**©2022 Diamond Dan  
Publications**

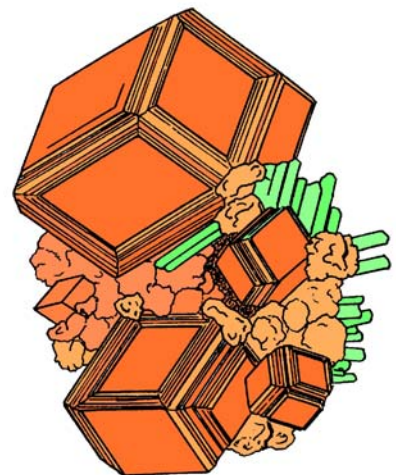

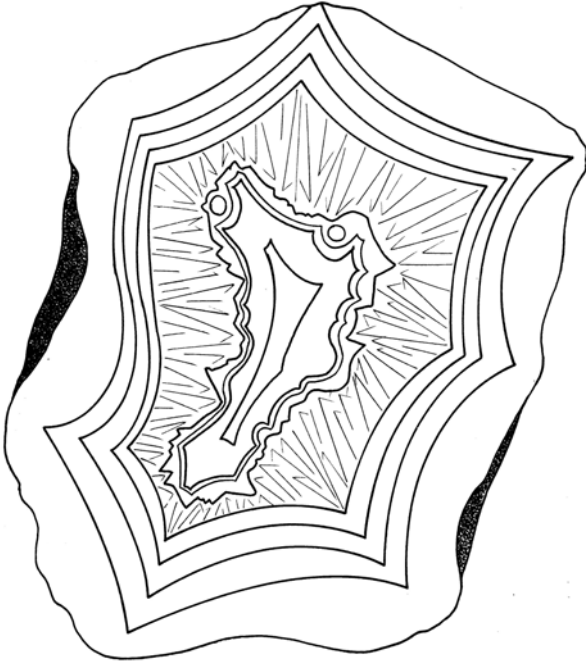

**Agate**

**Red, white, yellow, brown,  
blue, orange**

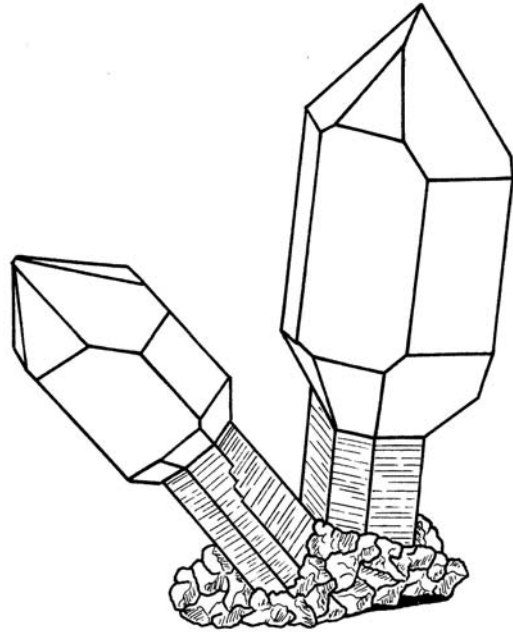

**Amethyst**

**Light to dark purple**

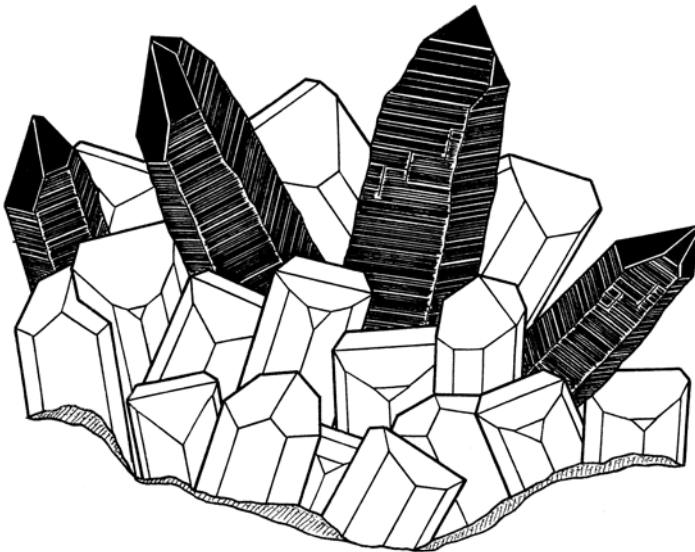

**Feldspar var.**

**Amazonite**

**Green**

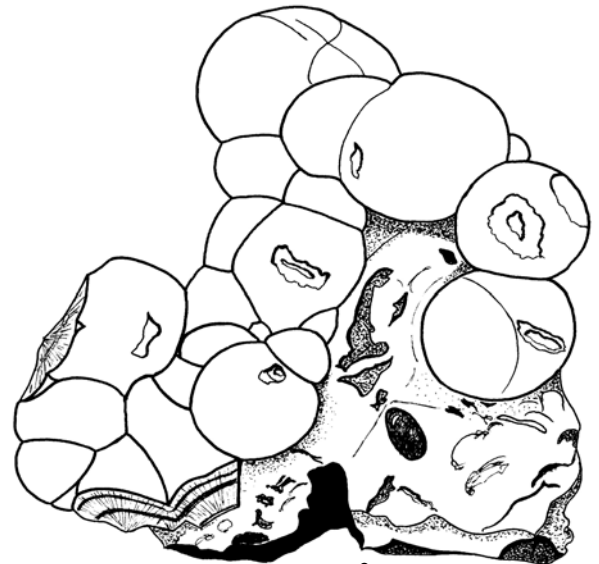

**Azurite**

**Light Blue**

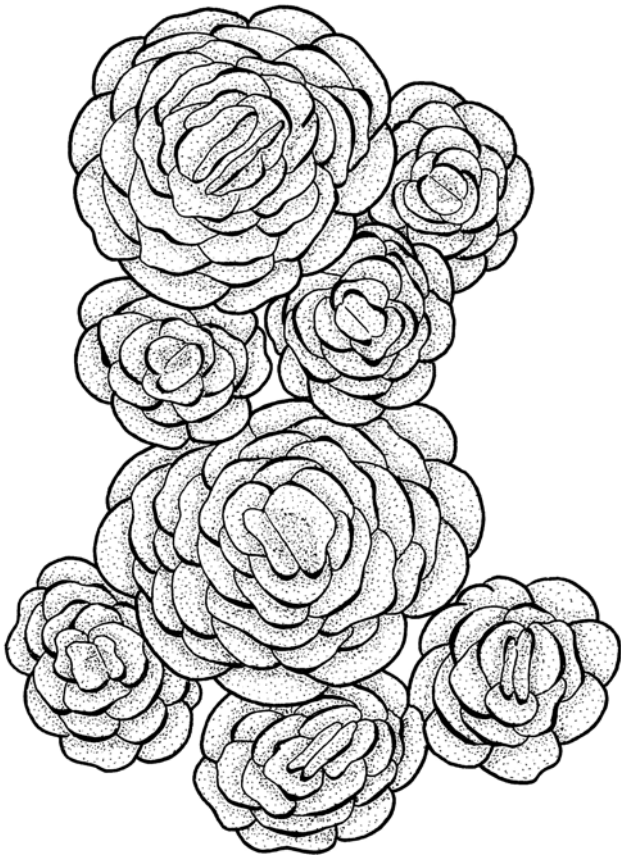

**Barite "Rose"**  
Rust Red

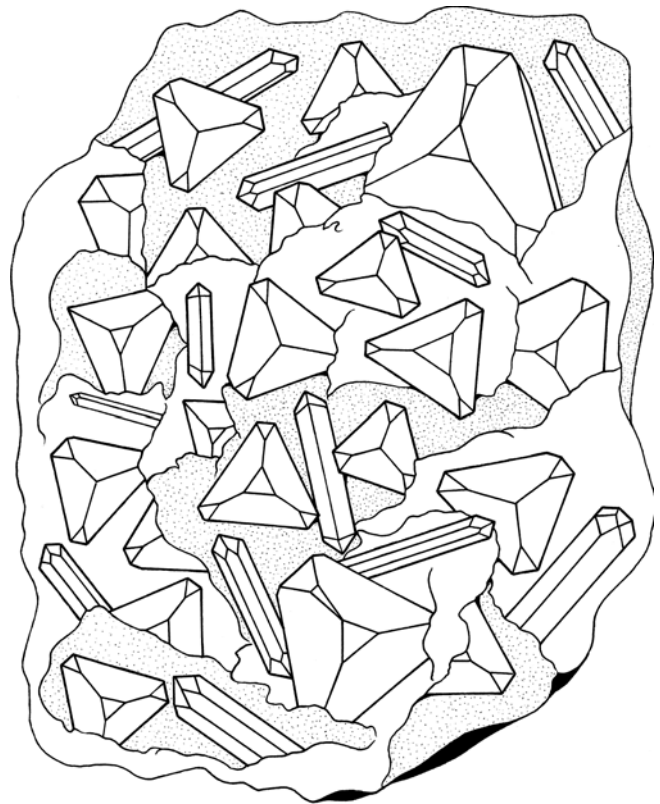

**Benitoite and Neptunite**  
Light Blue and Deep Red

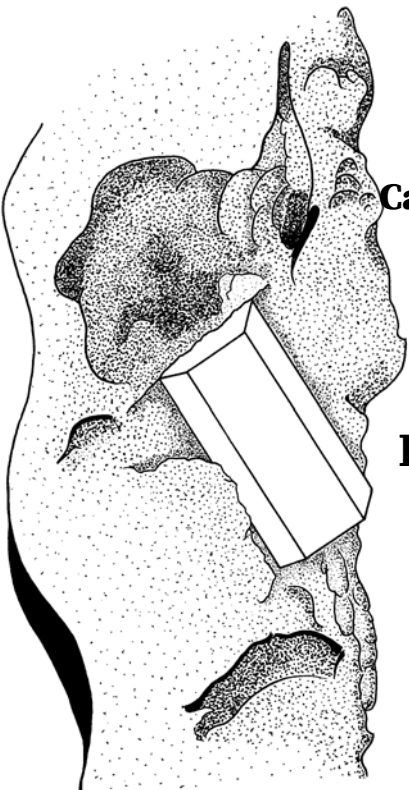

**Left: Beryl**  
Can be red, blue, green, pink



**Right: Aquamarine**  
Light Blue

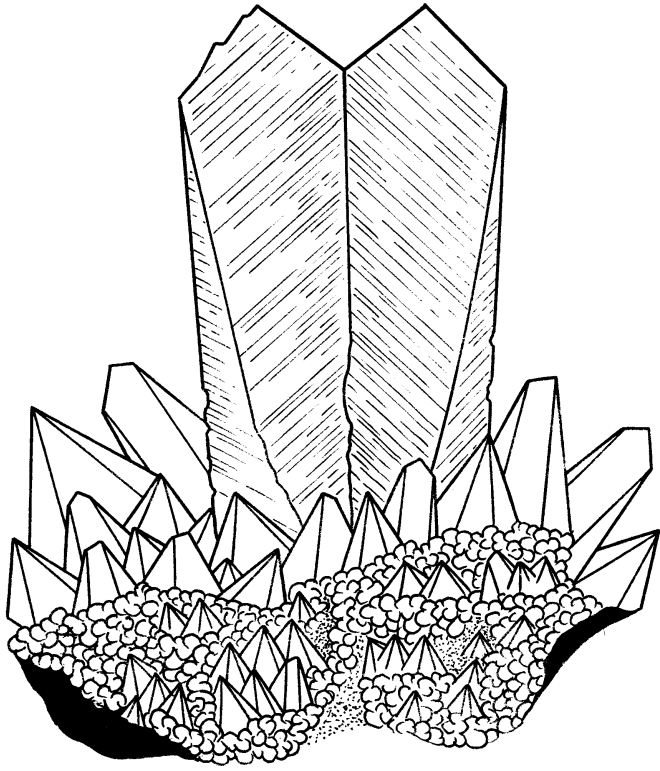

**Calcite**

**Gray, yellow, brown, green, blue, golden**

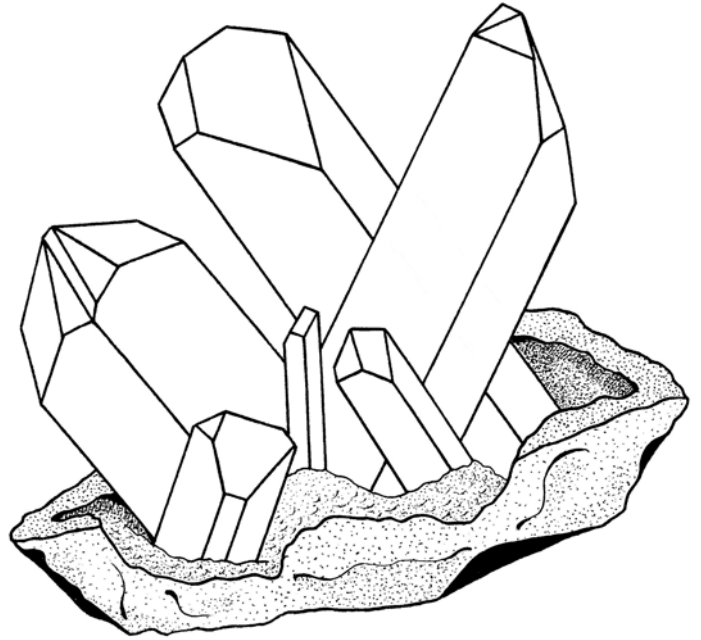

**Celestine**

**Light Blue**

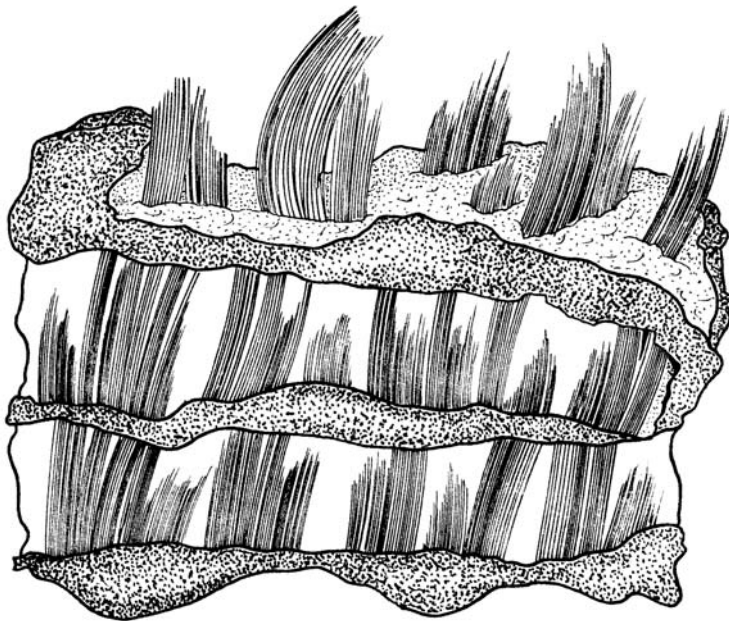

**Chalcantite**

**"Electric" blue**

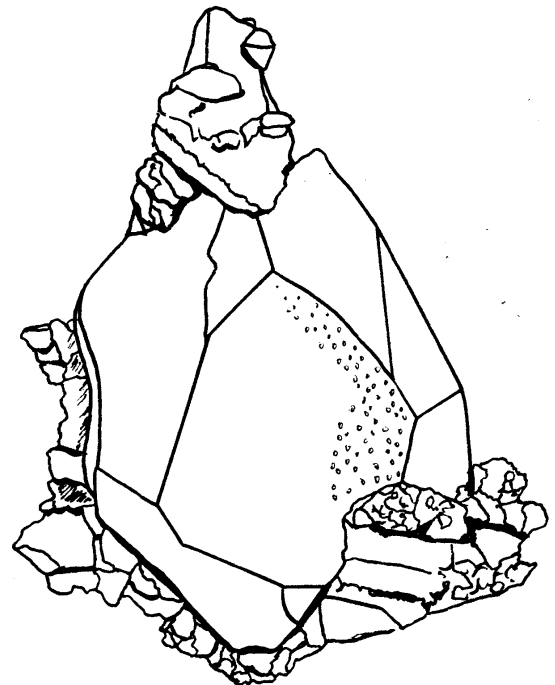

**Copper**

**"Copper" Red**

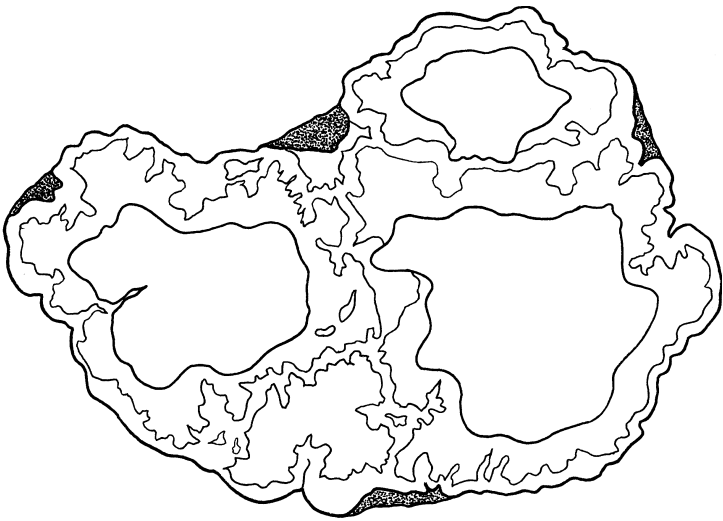

**Datolite**  
**Pink Areas on White**

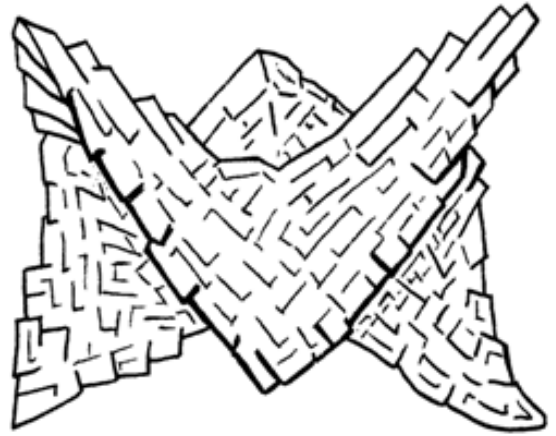

**Dolomite**  
**Light Pink**

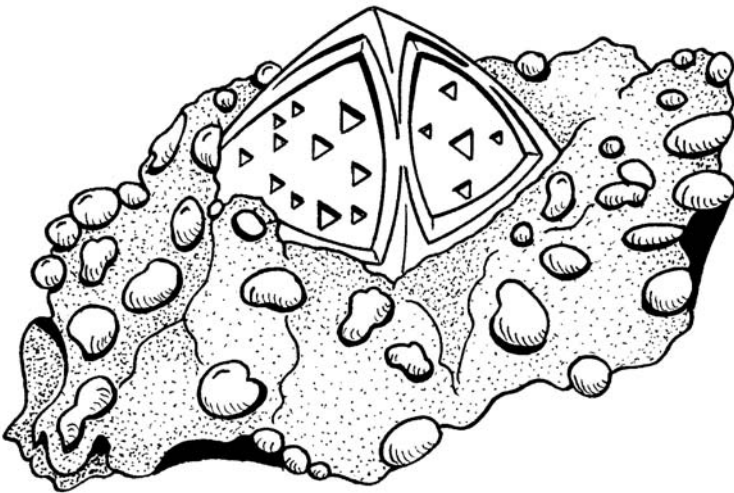

**Diamond**  
**Colorless, Yellow, Red, Blue**

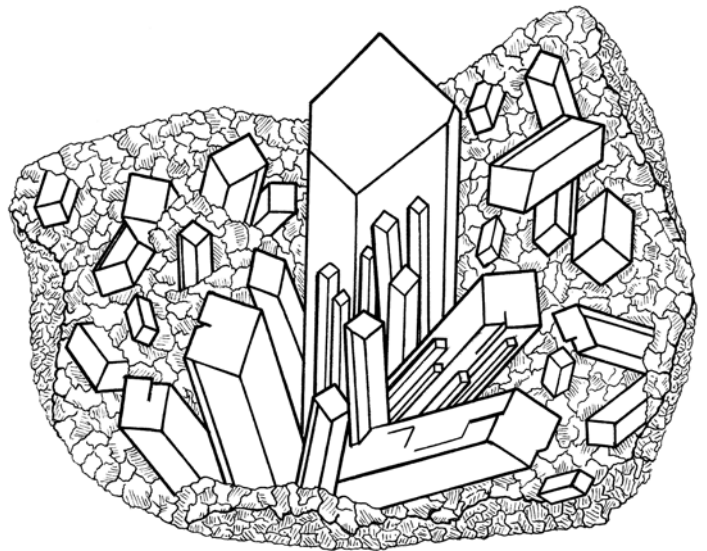

**Diopside**  
**Green**

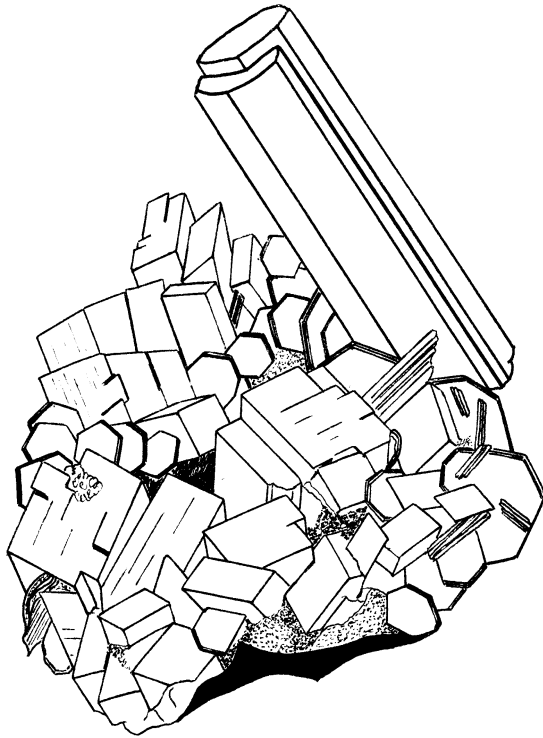

**Emerald**  
Green

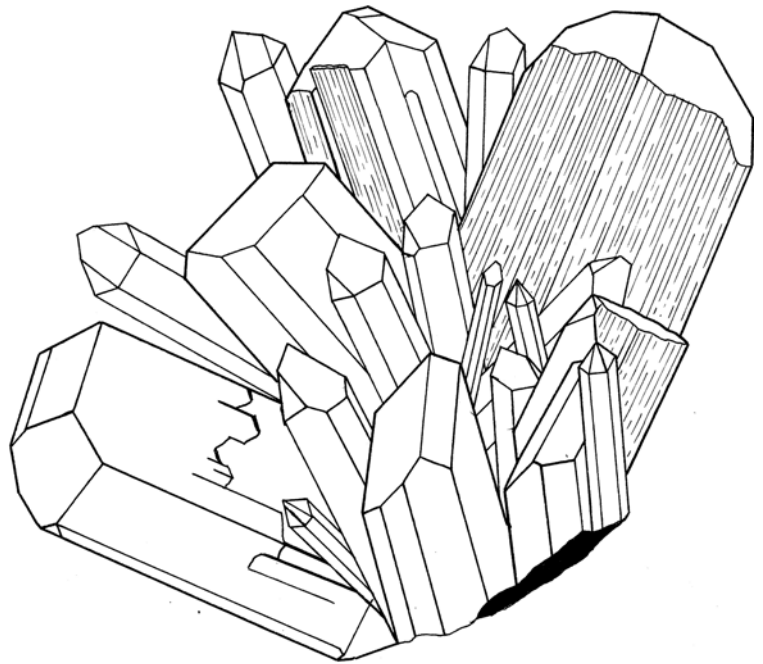

**Epidote**  
Dark Green



**Erythrite**  
Red-purple

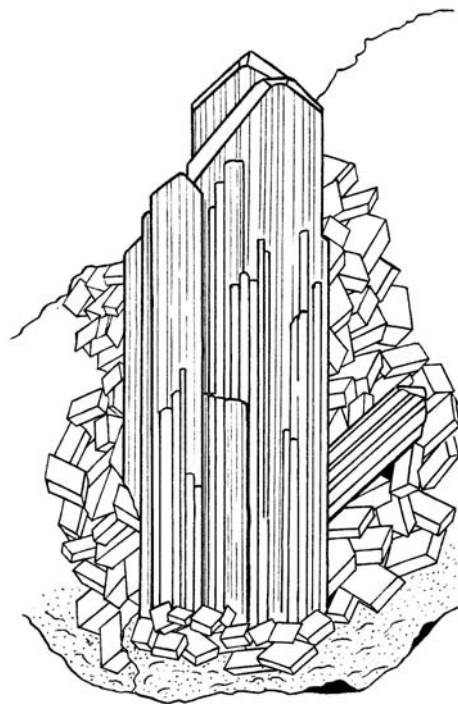

**Euclase**  
Blue

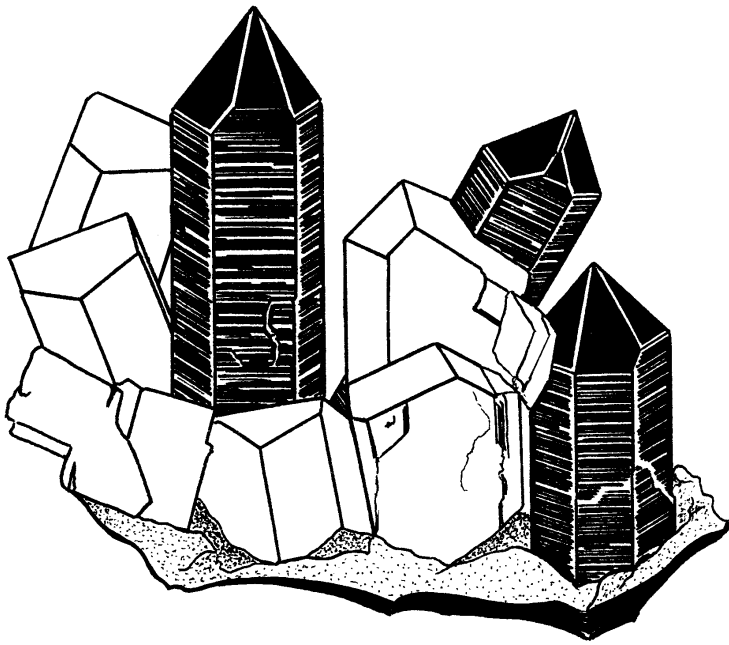

**Feldspar**  
**Flesh-pink**

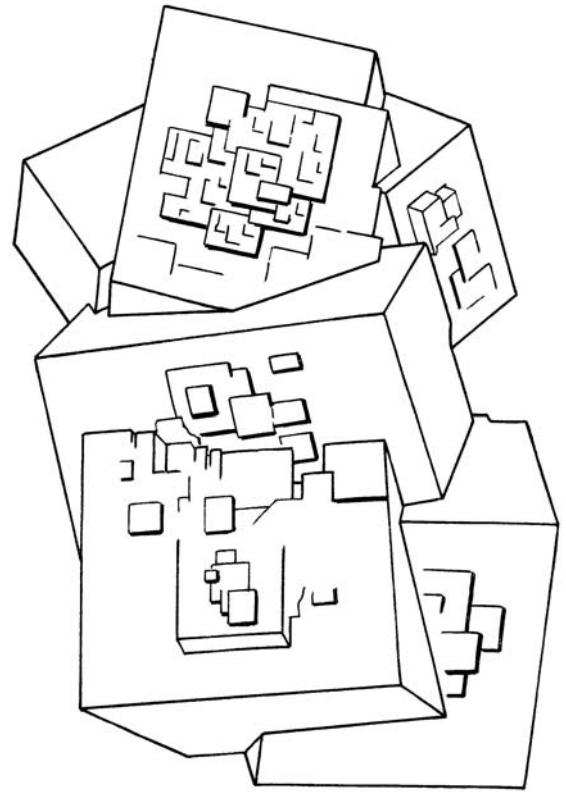

**Fluorite**  
**Purple, Blue, Yellow, Brown**

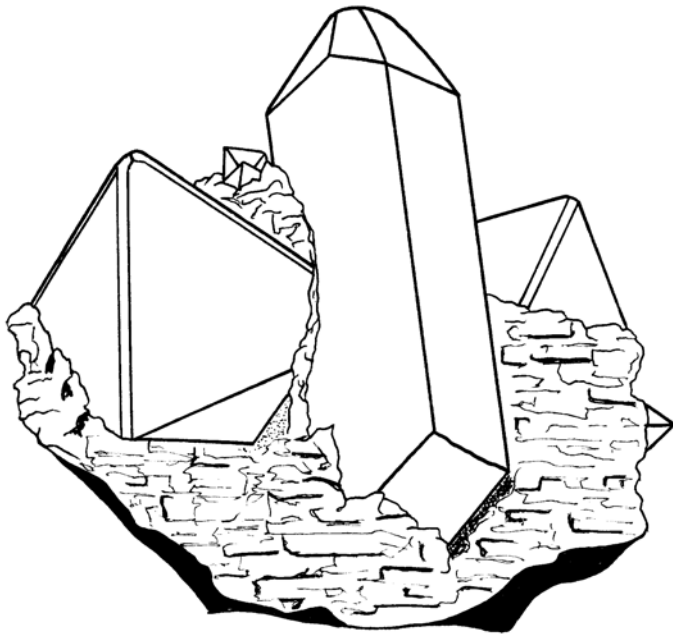

**Franklinite and Willemite**  
**Black and light tan**

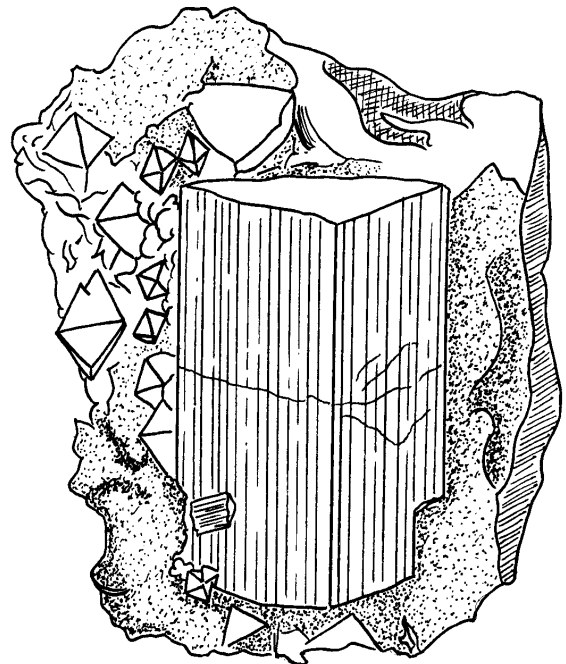

**Fluorapatite**  
**Yellow**

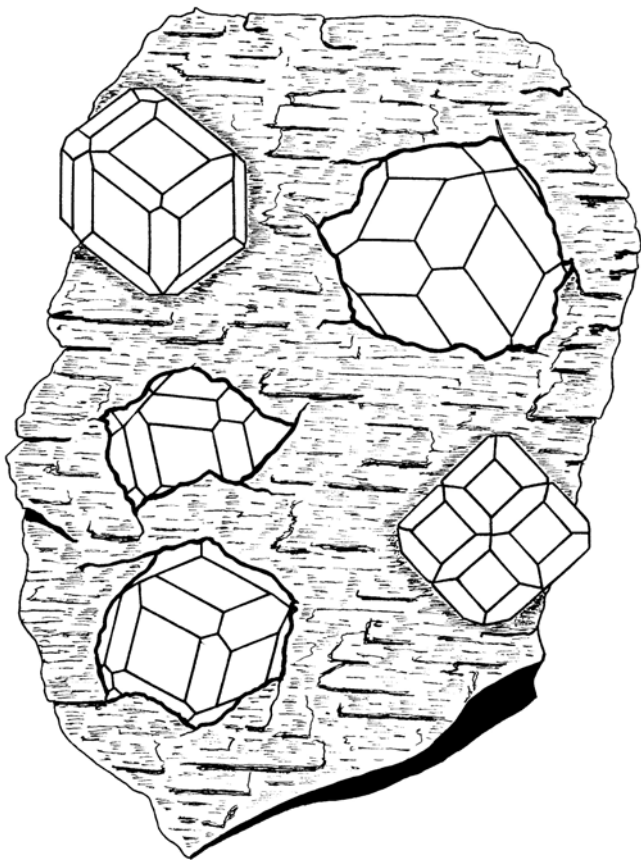

**Garnet**  
**Deep Red**

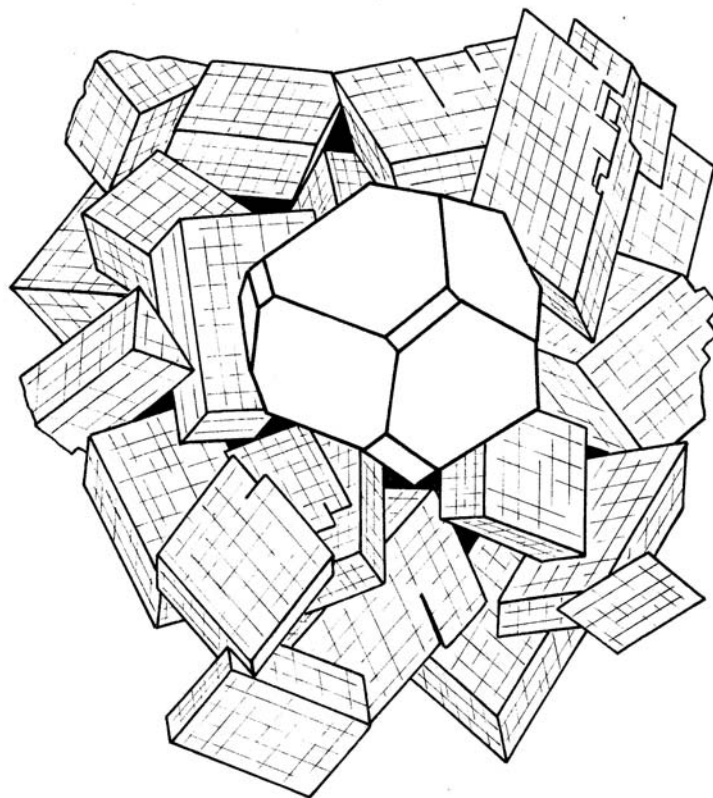

**Galena on Siderite**  
**Metallic silver on green-brown**



**Gold Crystals**  
**Metallic golden yellow**

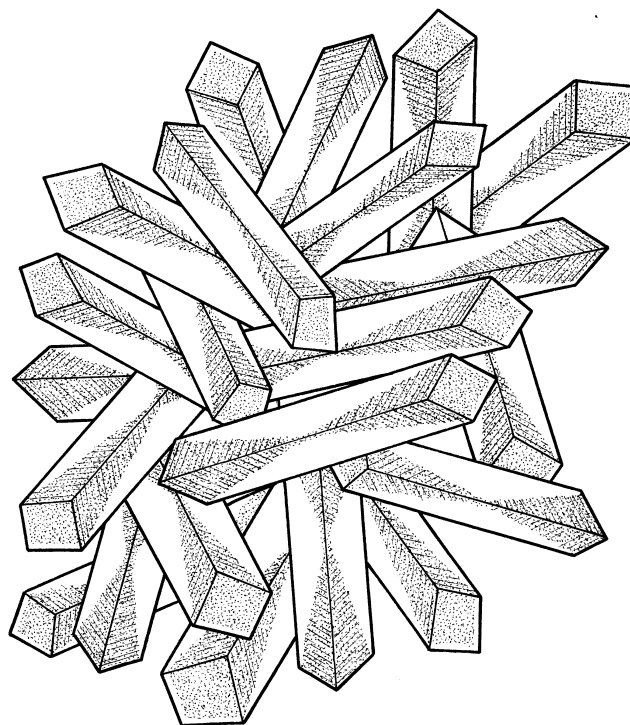

**“Hourglass” Gypsum**  
**Rust Red**



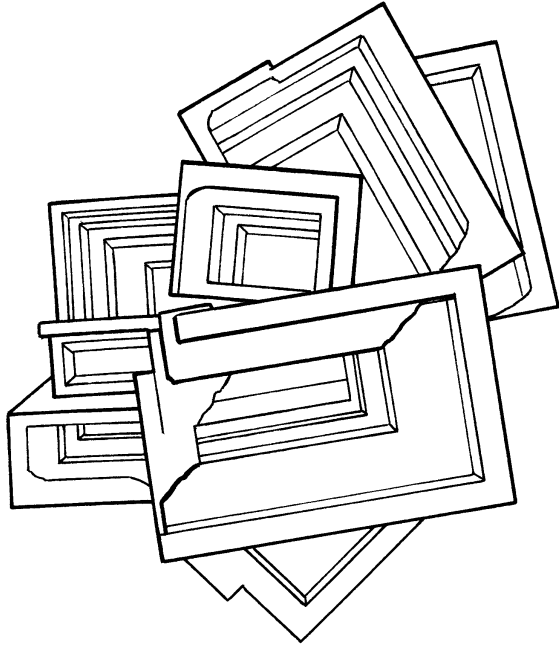

**Halite**  
**Pink**

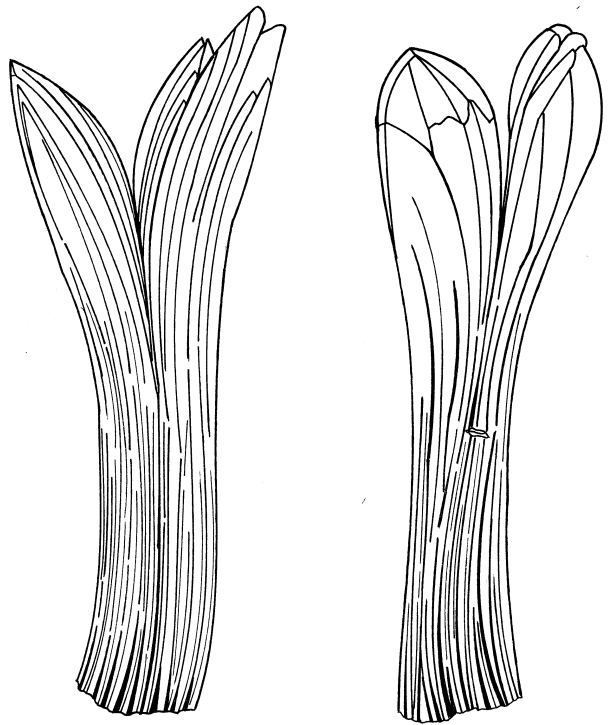

**Hematite**  
**Dark Brown**

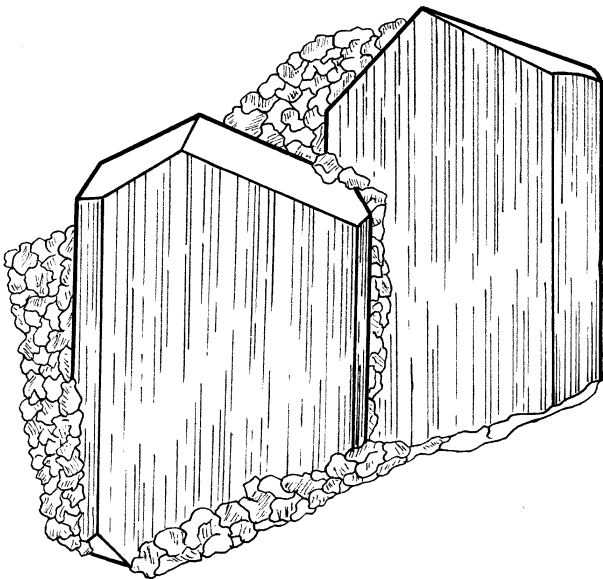

**Hiddenite**  
**Grass Green**

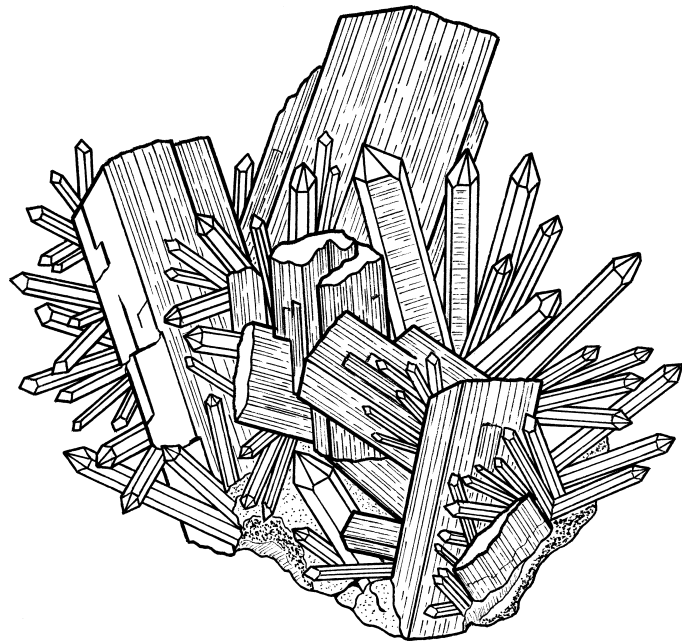

**Hubnerite**  
**Deep Red**

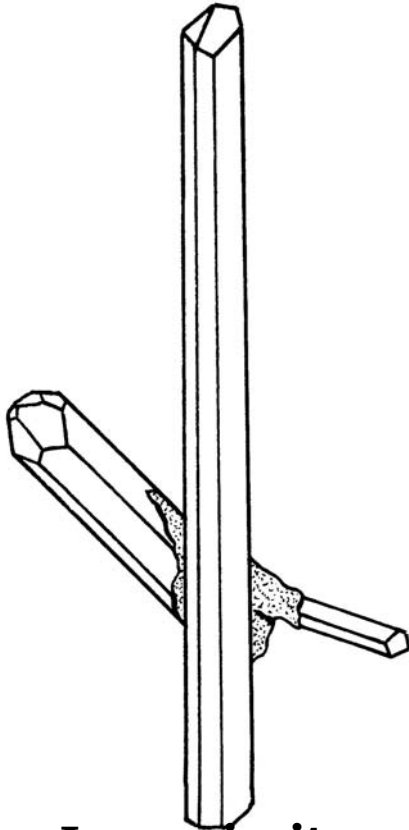

**Jeremyjevite**  
Light Blue

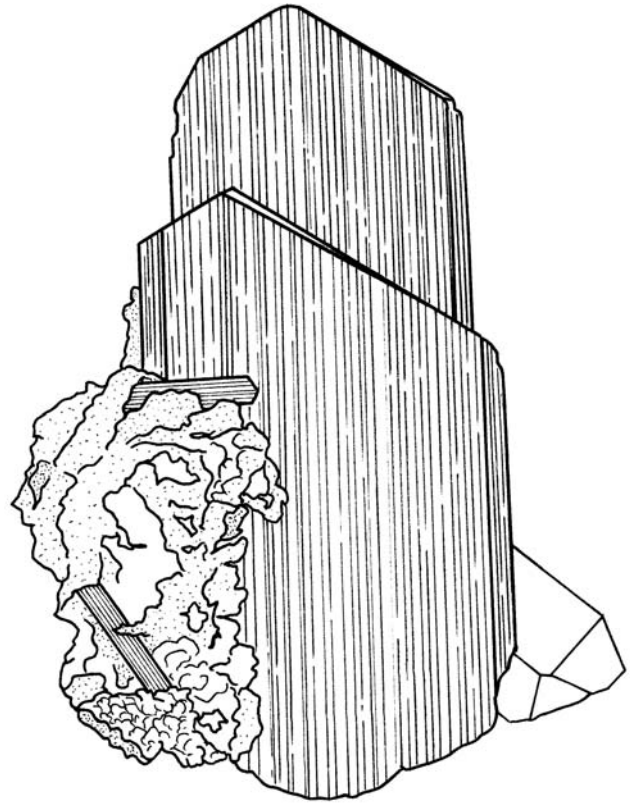

**Kunzite**  
Light Purple

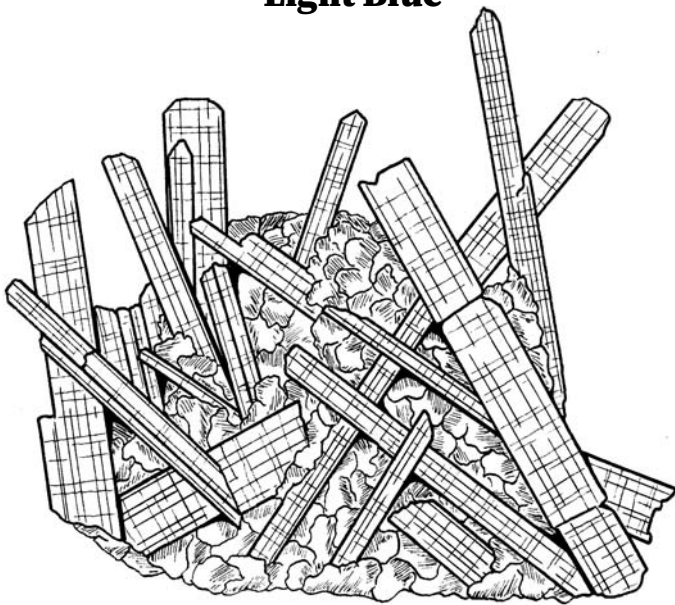

**Kyanite**  
Blue and Green

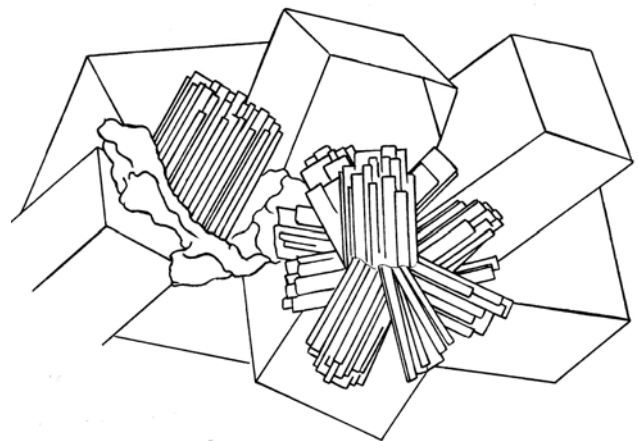

**Kinoite**  
Blue

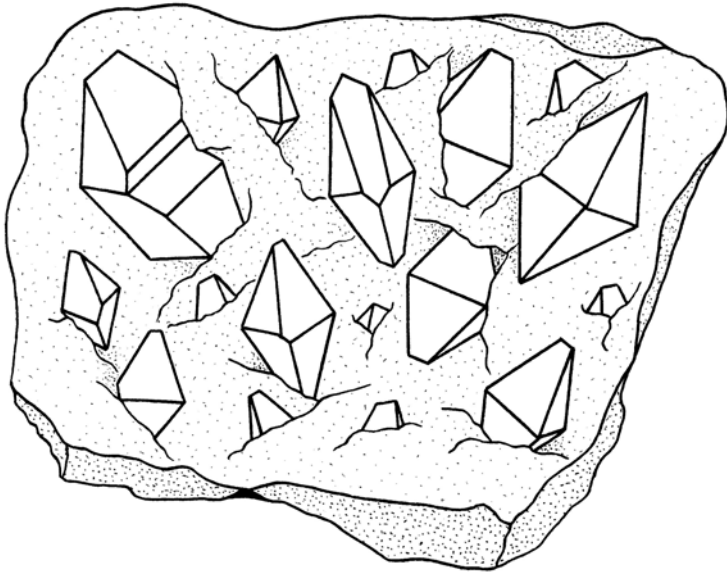

**Lazulite**  
Blue

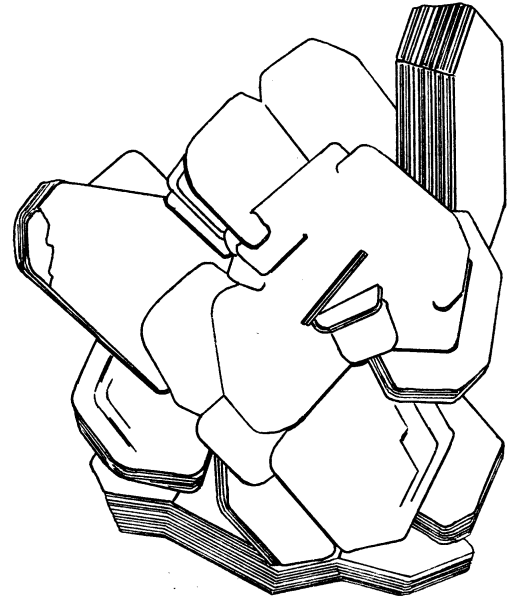

**Lepidolite**  
Purple

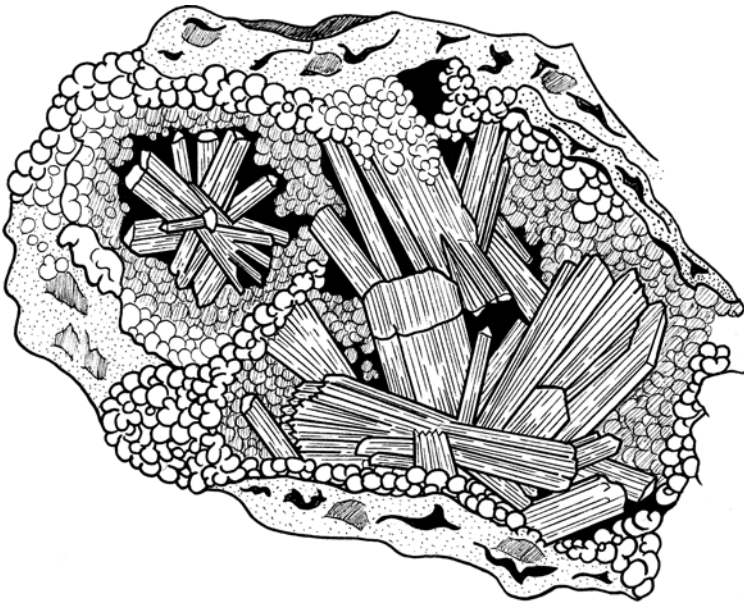

**Legrandite**  
Bright Yellow

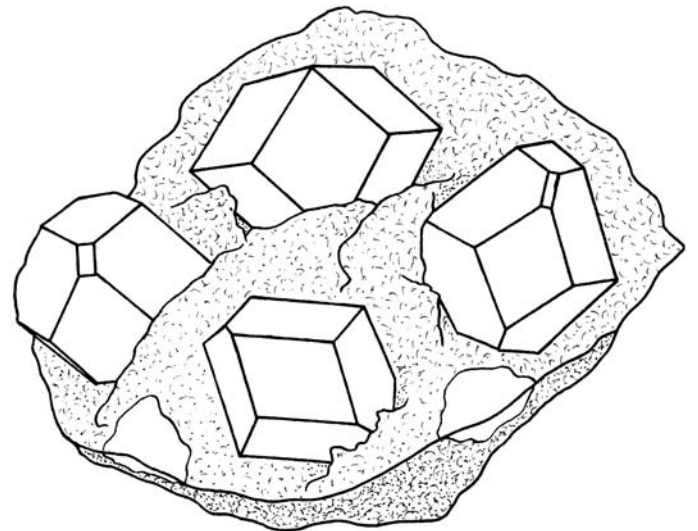

**Lazurite**  
Dark Blue

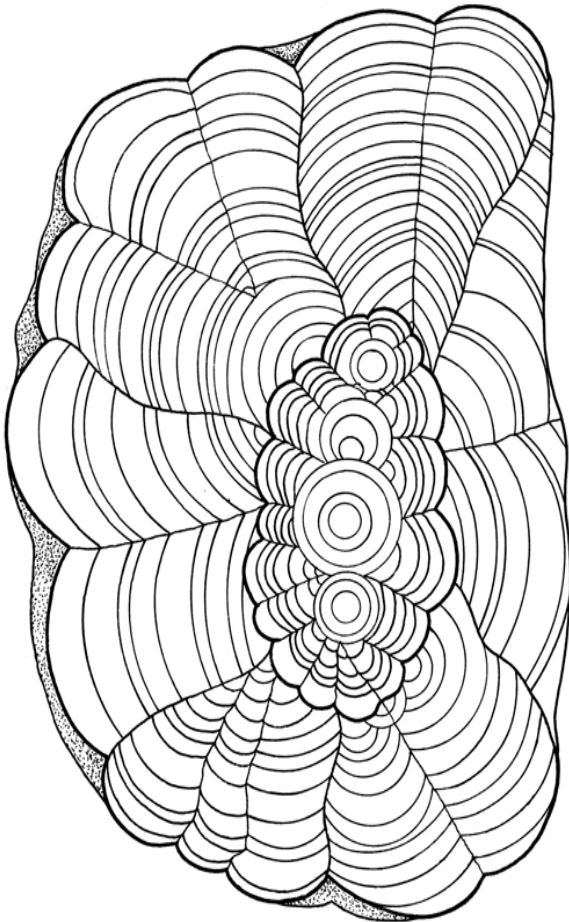

**Malachite**  
Shades of Green

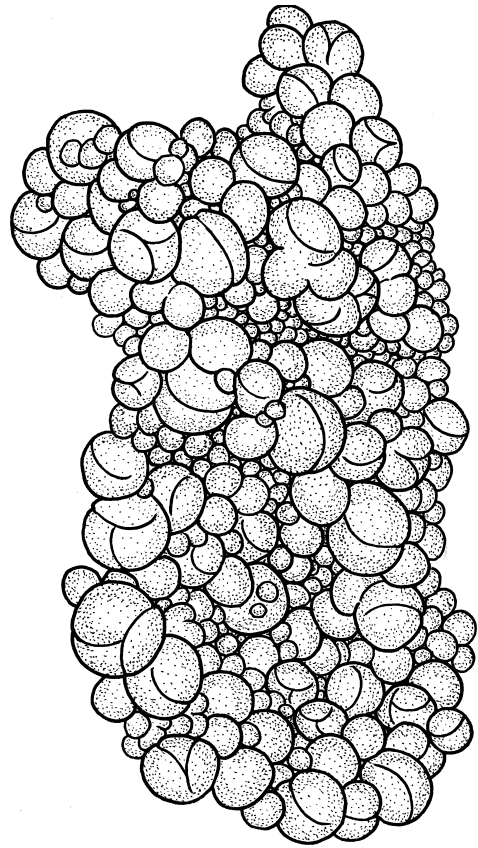

**Mimetic**  
Lemon Yellow

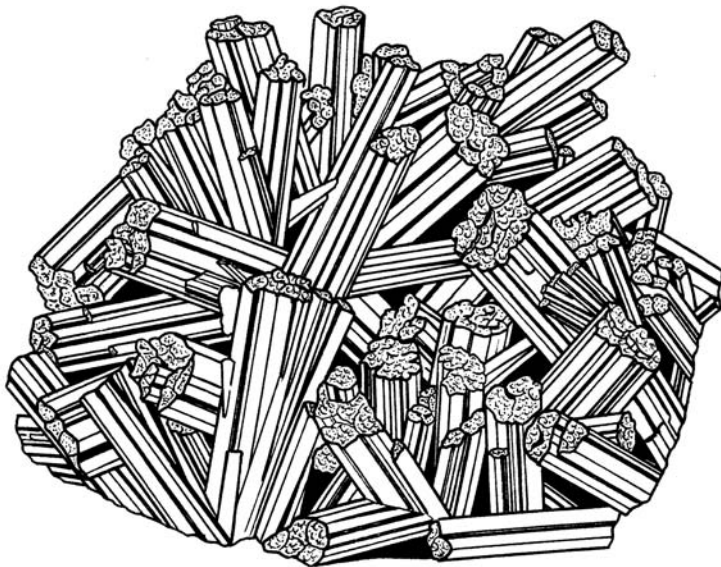

**Manganite**  
Lead Gray

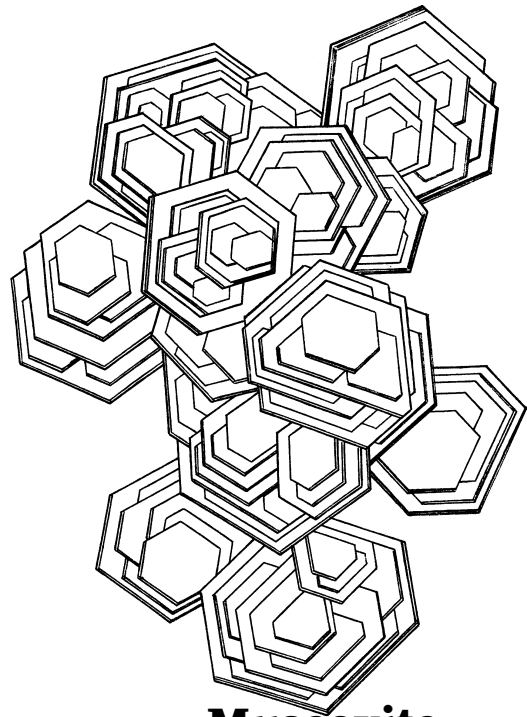

**Muscovite**  
Silver to Light Yellow

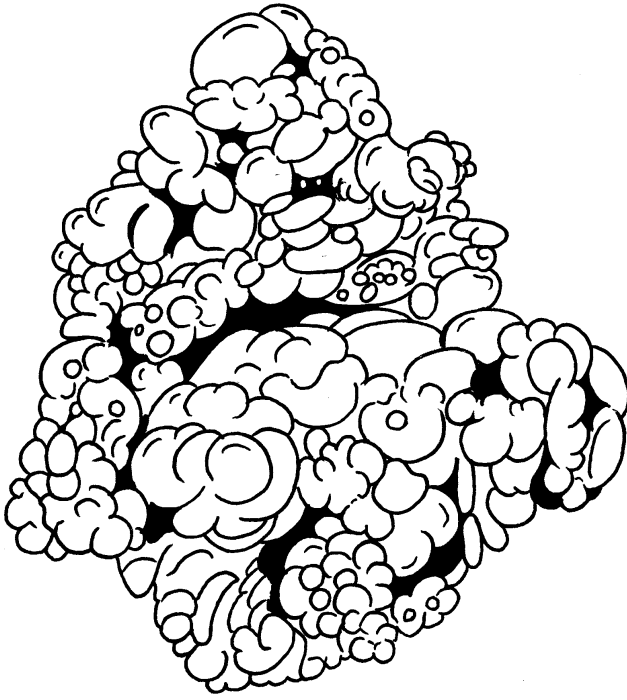

**Nephrite Jade**  
Dark Green

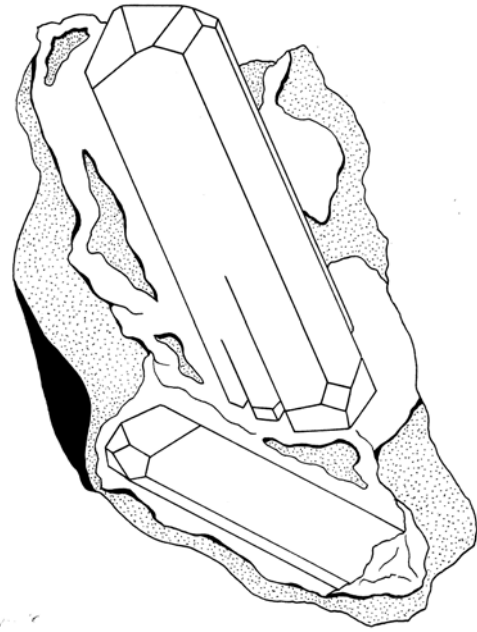

**Neptunite**  
Deep Red to Black

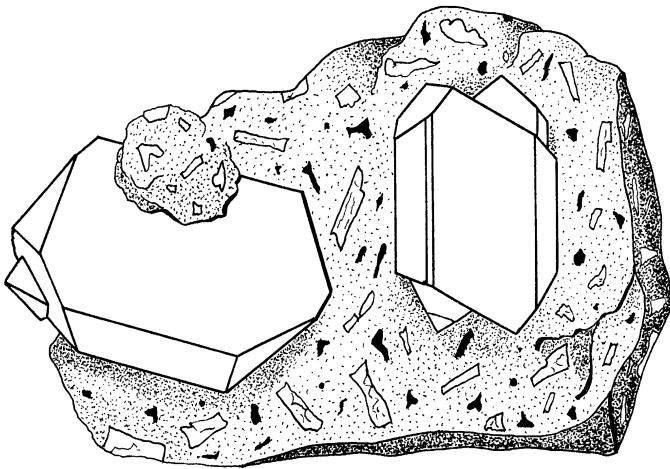

**Orthoclase Feldspar**  
Light Tan

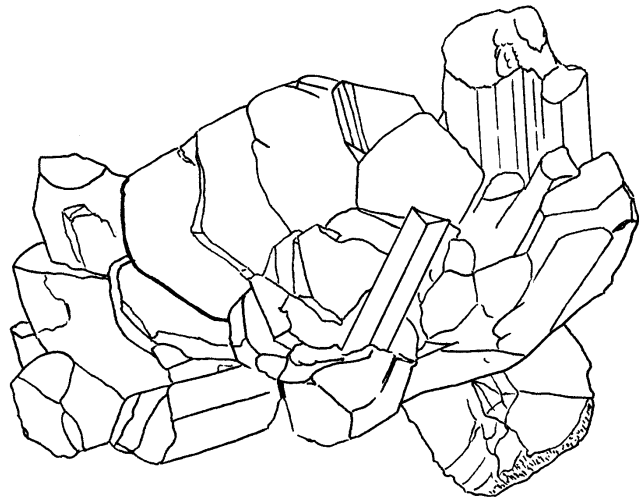

**Orpiment**  
Amber Yellow

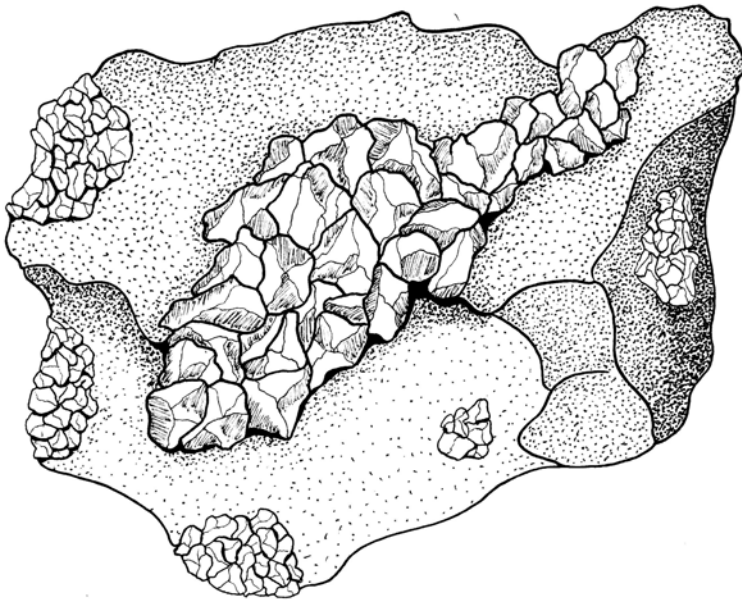

**Olivine var. Peridot**  
**Green**

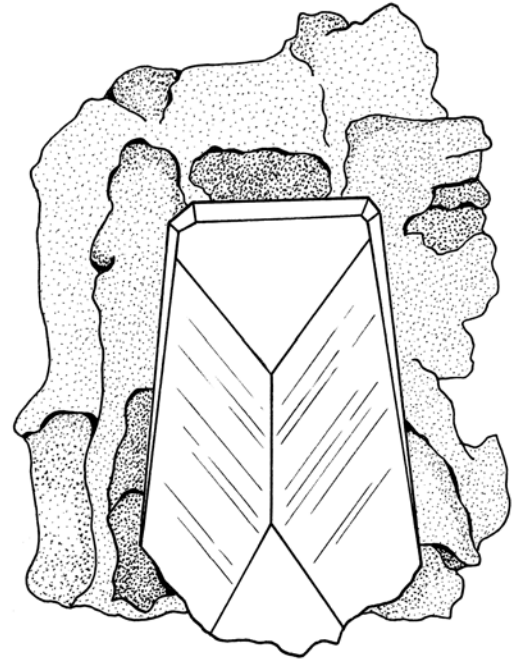

**Phosphophyllite**  
**Gray-Blue**

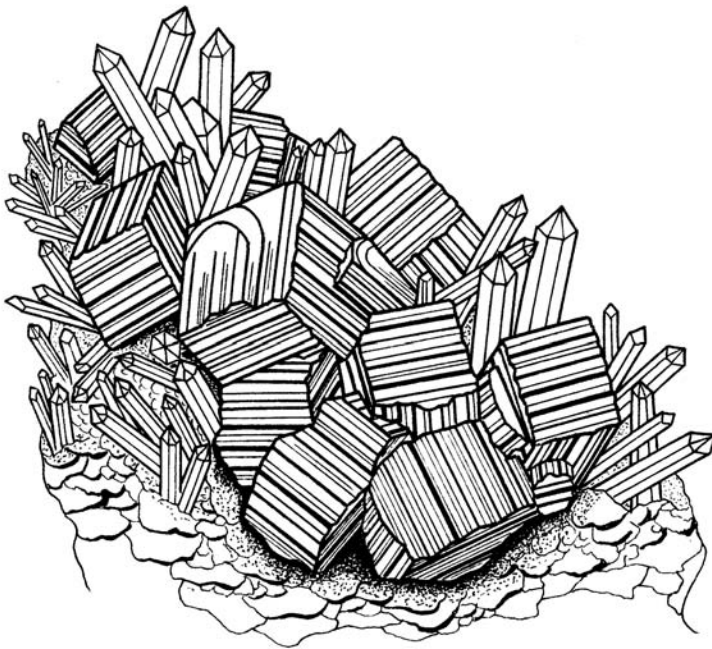

**Pyrite**  
**Brassy-Yellow**

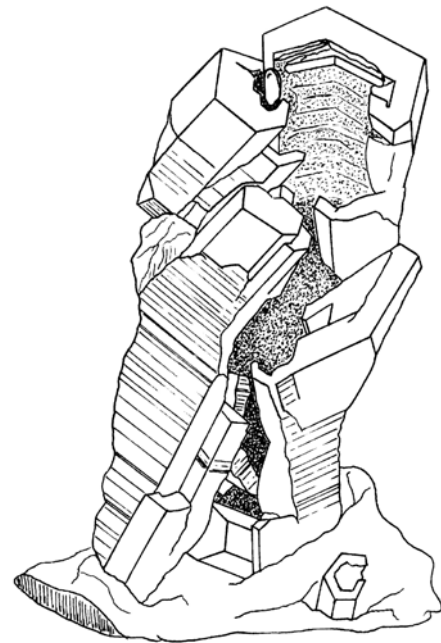

**Pyromorphite**  
**Bright Green**

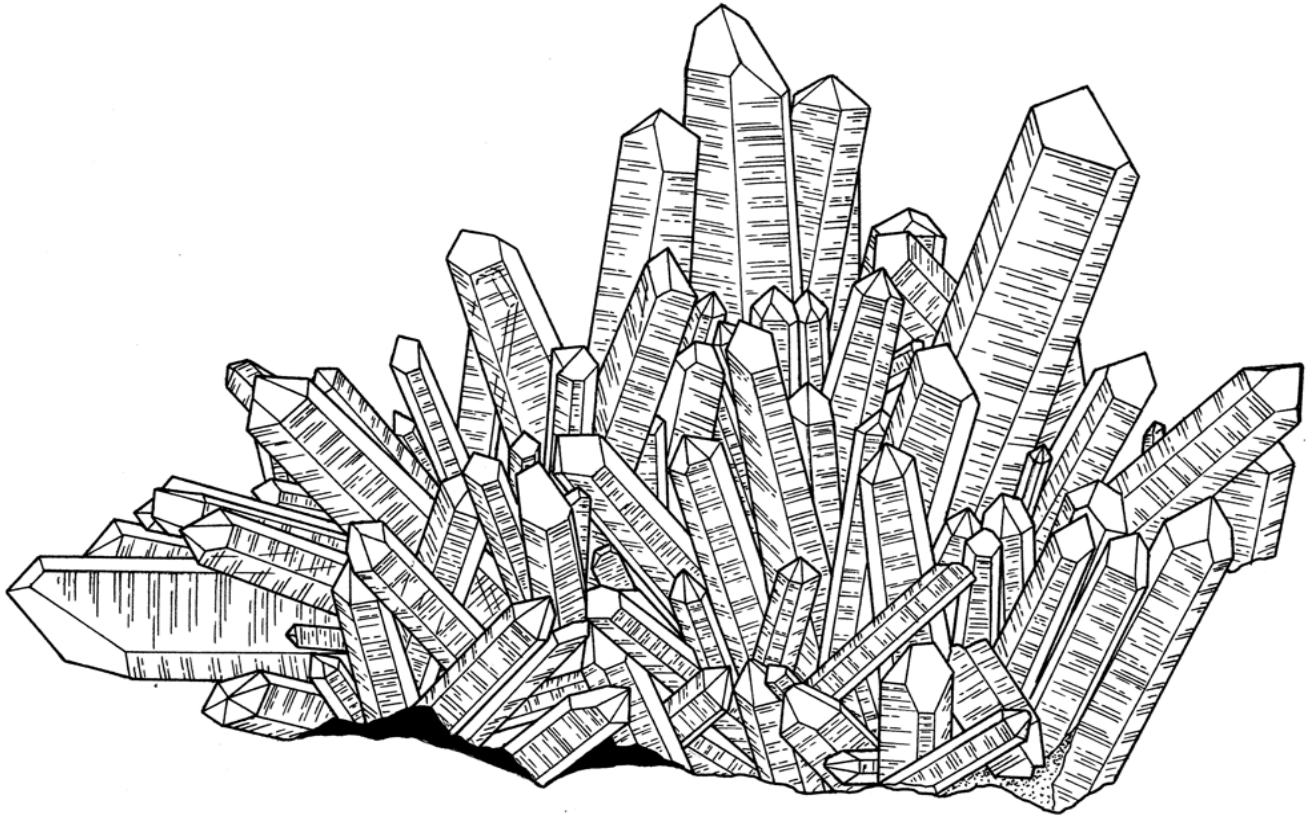

## **Quartz**

**Colorless, purple, yellow, black, brown, green, blue**

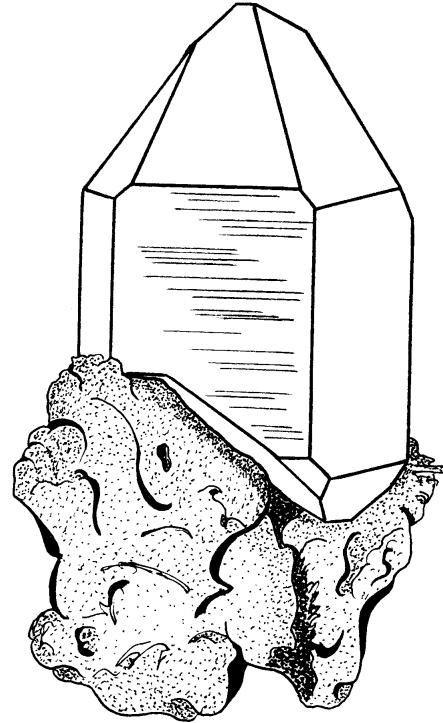
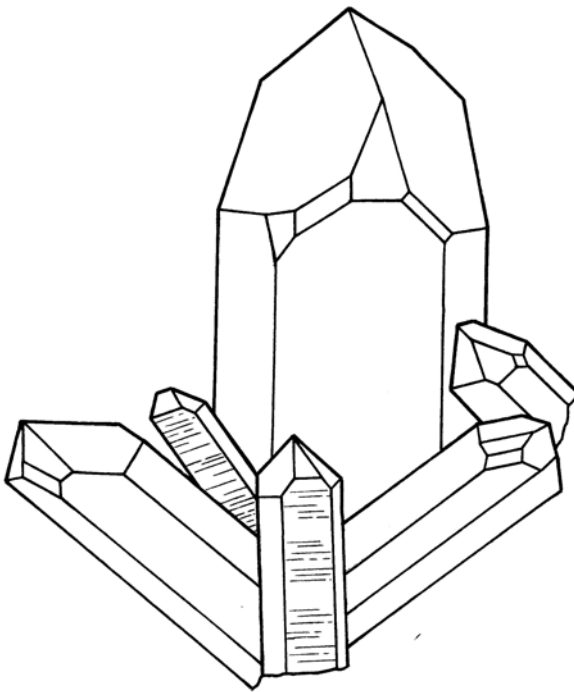

**[www.diamonddanpublications.net](http://www.diamonddanpublications.net)**

**[www.bonfire.com/store/diamond-dans-mineral-fun-store/](http://www.bonfire.com/store/diamond-dans-mineral-fun-store/)**

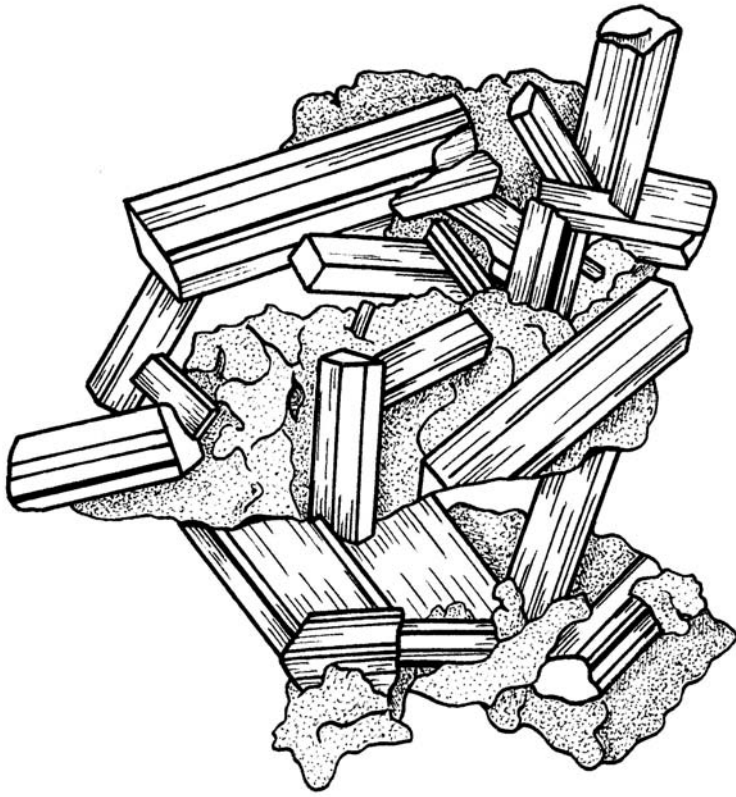

**Realgar**

**Red**

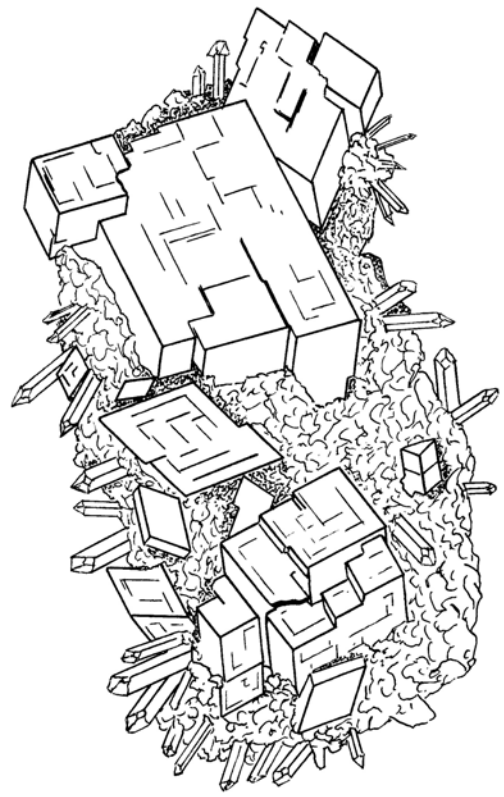

**Rhodochrosite**

**Bright Red**

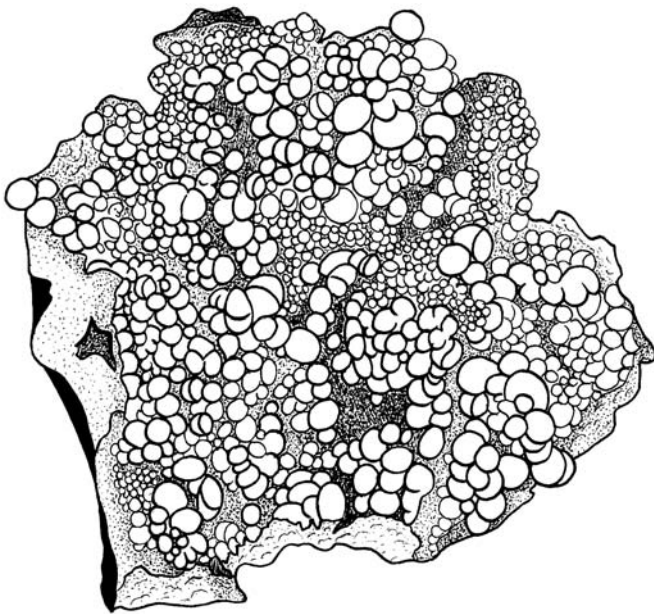

**Rosasite**

**Blue**

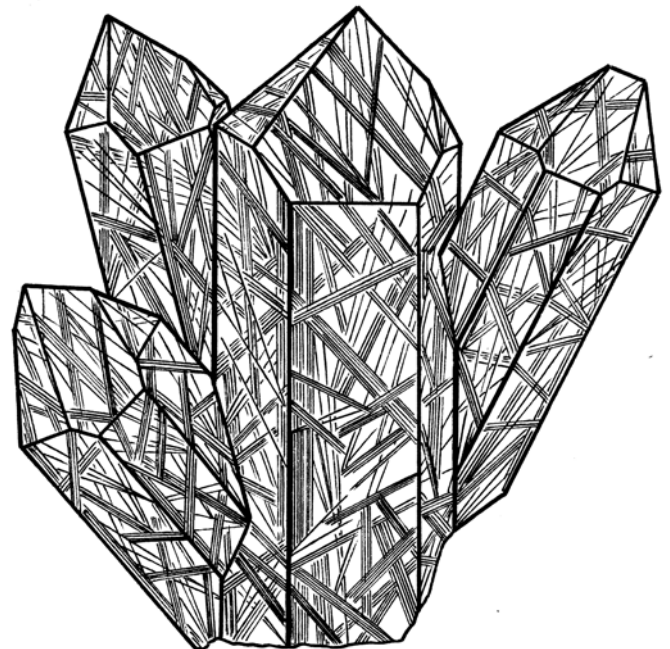

**Rutile in Quartz**

**Golden needles in colorless Quartz**



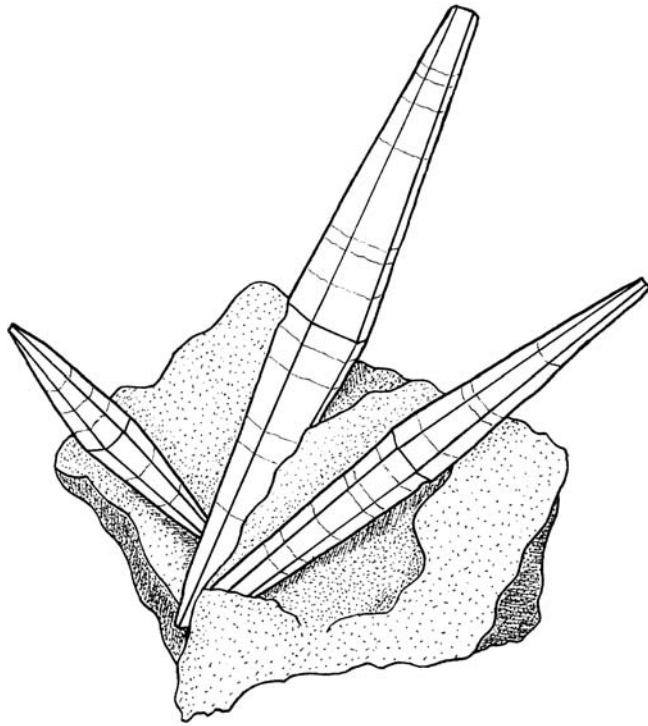

**Ruby var. Sapphire**  
White, Blue, Yellow

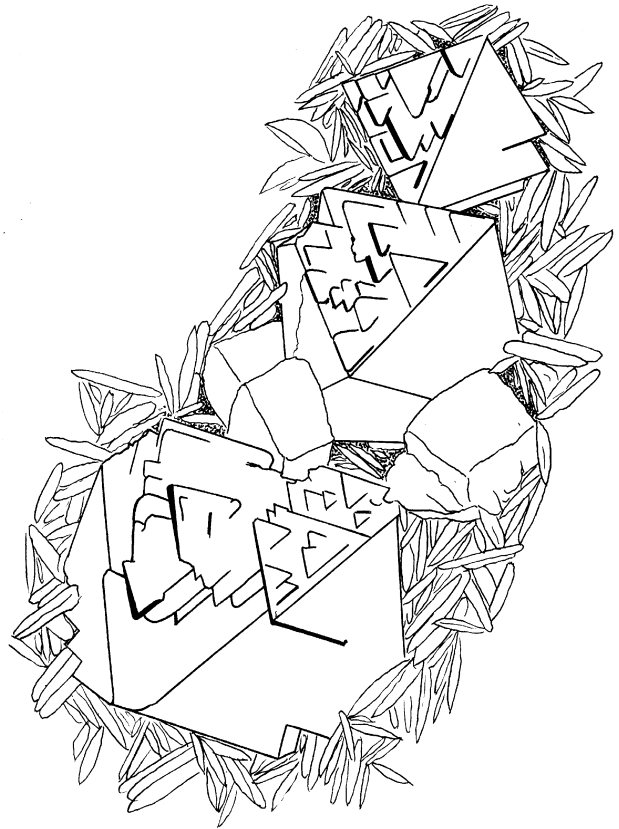

**Scheelite**  
Bright Orange

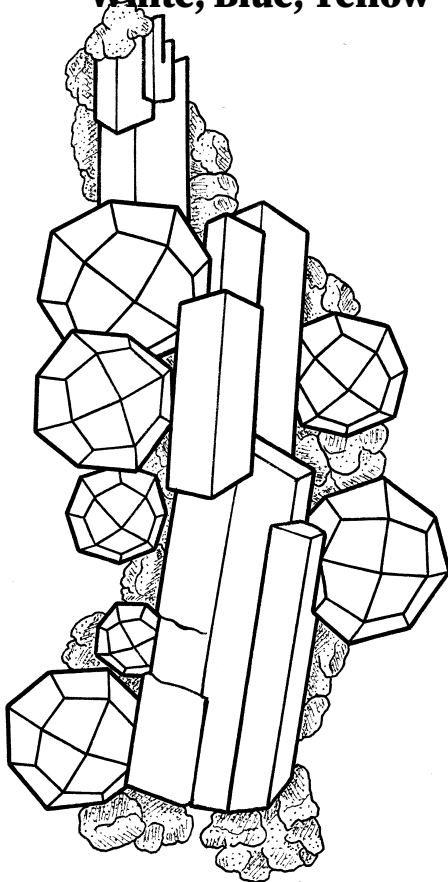

**Serandite**  
Pinkish-orange

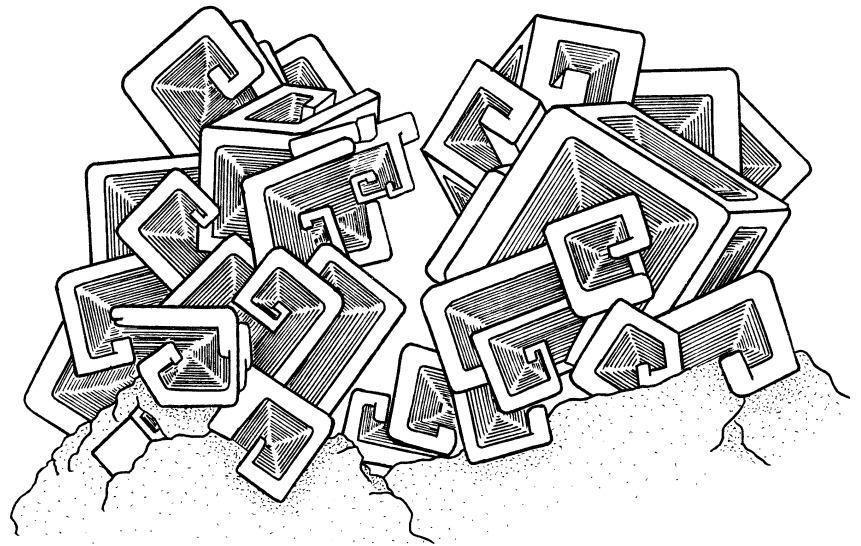

**Silver**  
Metallic Silver Gray

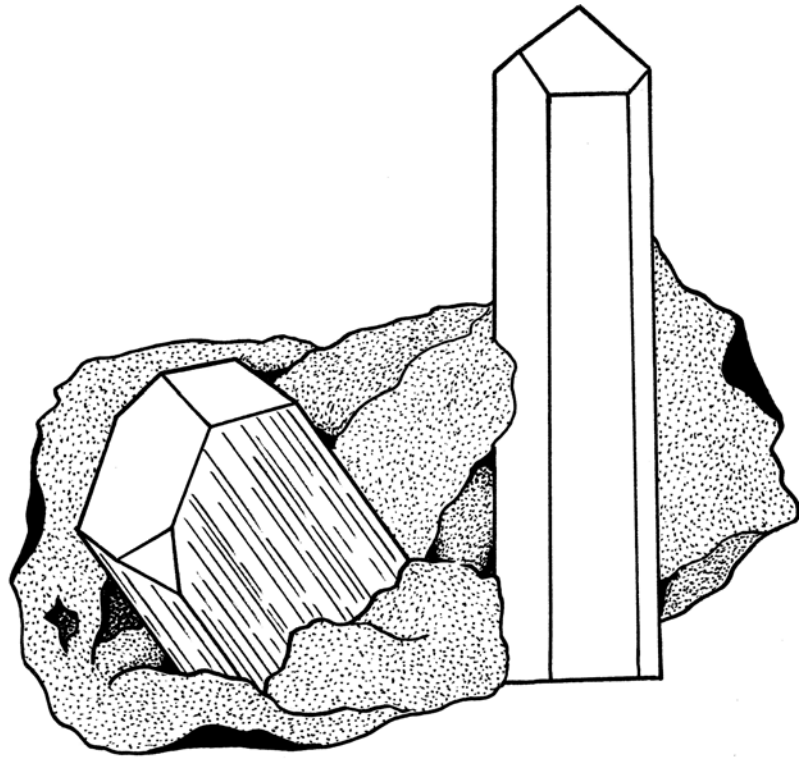
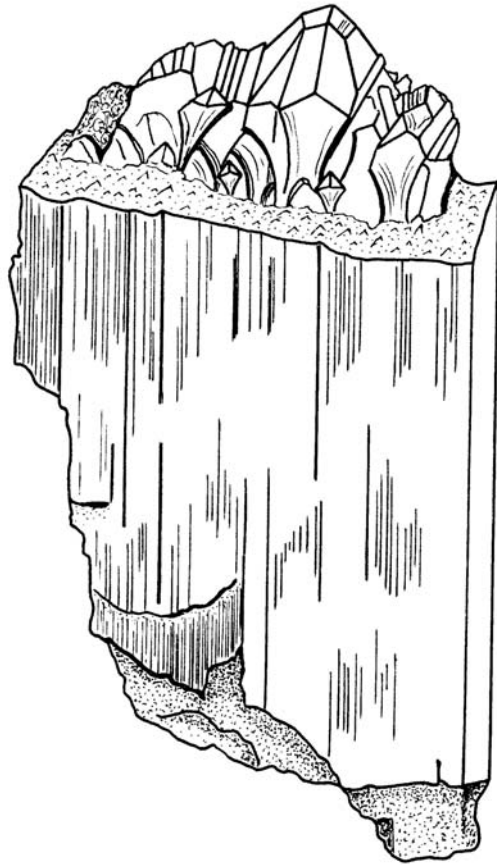

**Topaz**

**Yellow, brown, golden brown, blue**

**Tanzanite**  
**Deep Blue to Purple**

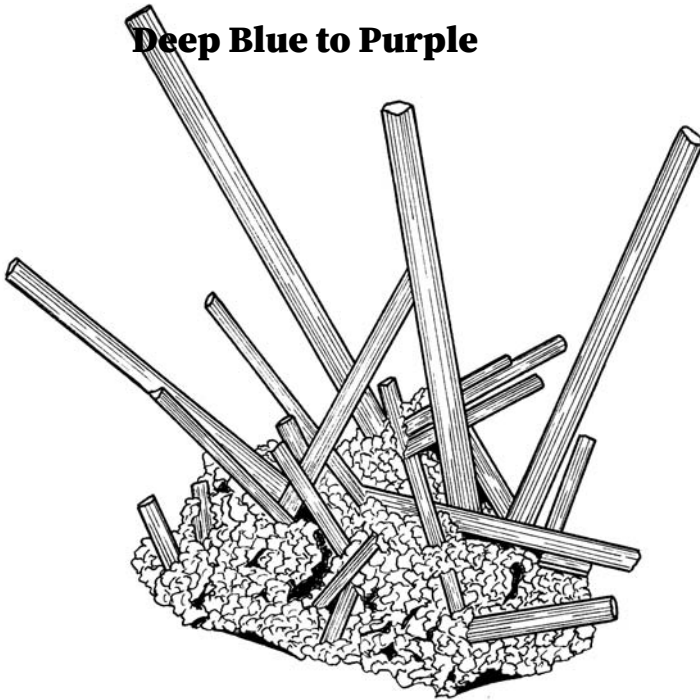

**Tourmaline**

**Yellow, green, blue, yellow, red**

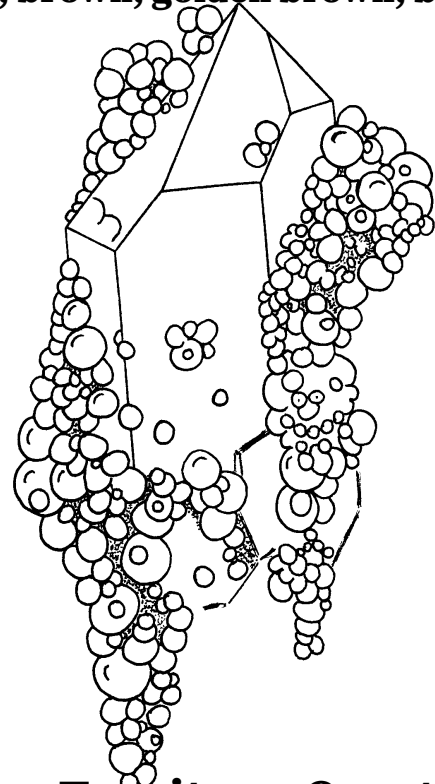

**Turgite on Quartz**

**Iridescent: blue, purple, red, blue,  
green**

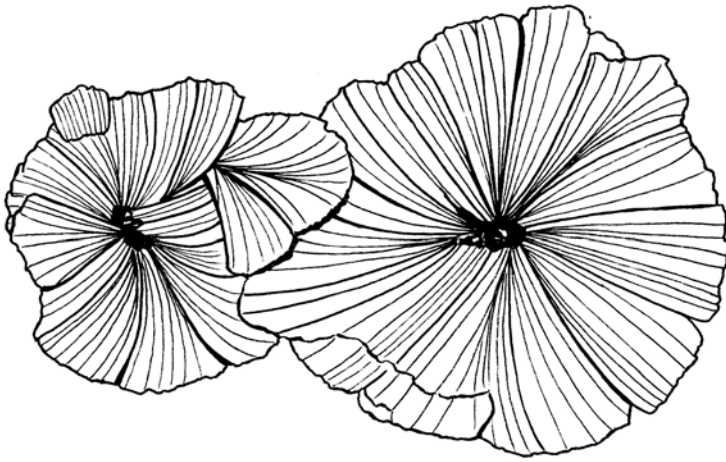

**Ulexite**  
Gray to Tan

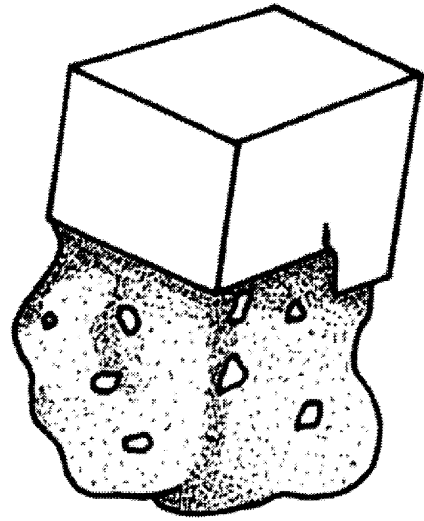

**Uraninite**  
Black

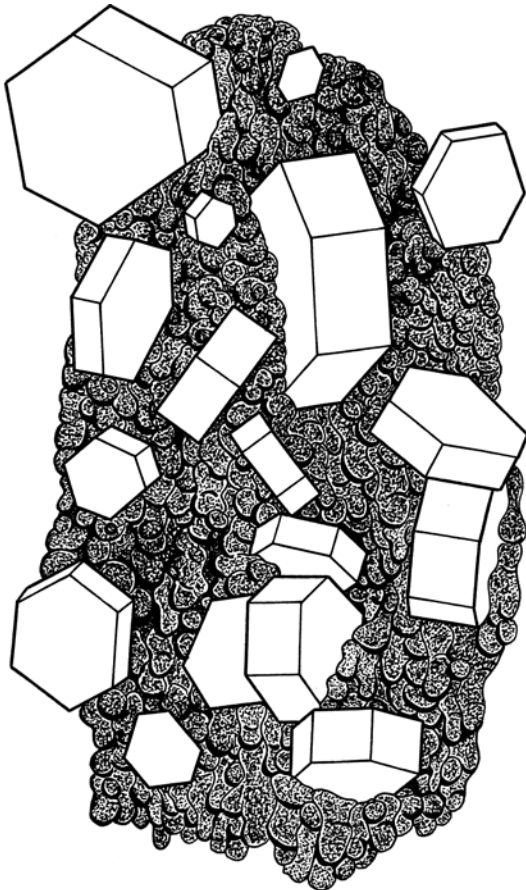

**Vanadinite**  
Bright Red

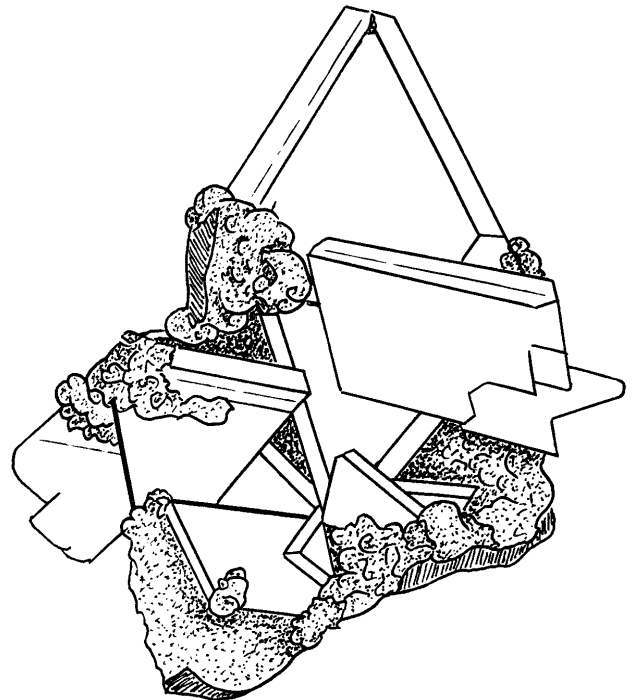

**Vivianite**  
Dark Green

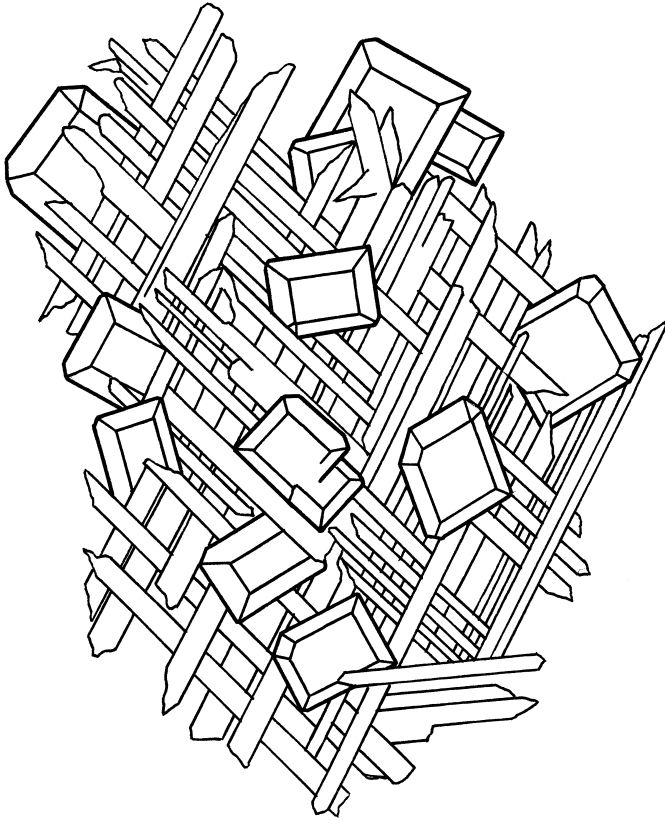

**Wulfenite on Cerussite**  
Orange on White

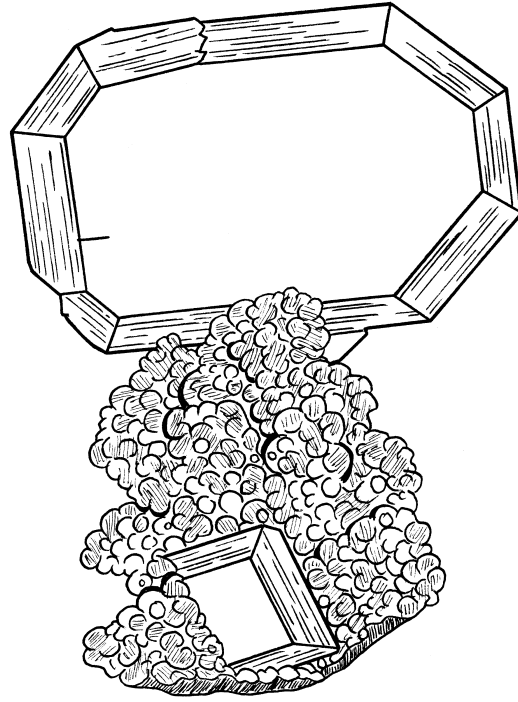

**Wulfenite**  
Bright Red

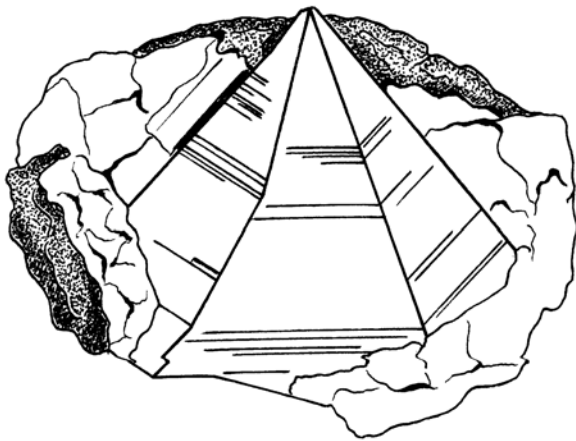

**Zincite**  
Red

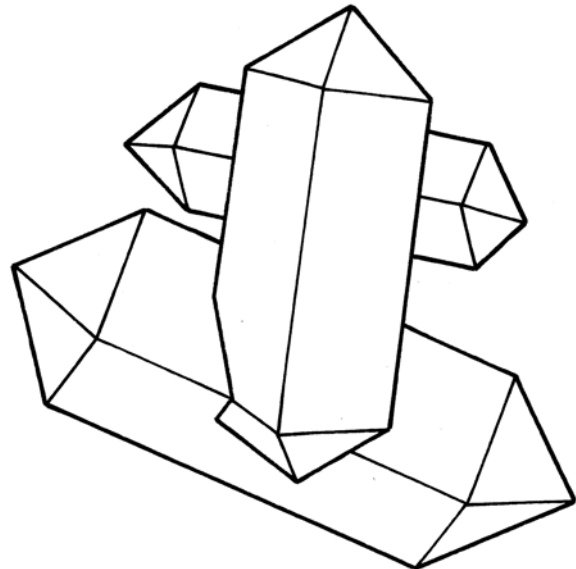

**Zircon**  
Tan to light Brown

